

GRIFO MANOMETRO FIG. 226

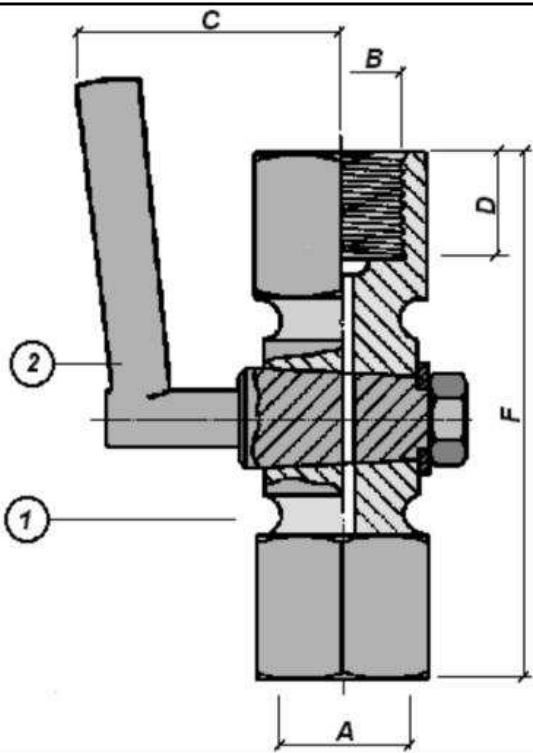

A	B	C	D	E	F	G	H
1/4"	1/4"	44	13		60		
3/8"	3/8"	47	17		74		
1/2"	1/2"	47	17		85		
3/4"	3/4"	62	24		100		
1	Cuerpo grifo				bronce		
2	Macho cierre (palanca)				bronce		
3							
FLUIDO	AIRE	AGUA	VAPOR				
PN max.	12	16	12	Kgs/cm ²			